

 **DATALOGIC**

Heron™ HD3130 Linear Imager



Quick Reference Guide

Datalogic USA, Inc.

959 Terry Street
Eugene, OR 97402
USA

Telephone: (541) 683-5700

Fax: (541) 345-7140

©2014-2017 Datalogic S.p.A. and/or its affiliates

♦ All rights reserved. ♦ Without limiting the rights under copyright, no part of this documentation may be reproduced, stored in or introduced into a retrieval system, or transmitted in any form or by any means, or for any purpose, without the express written permission of Datalogic S.p.A. and/or its affiliates.

Owners of Datalogic products are hereby granted a non-exclusive, revocable license to reproduce and transmit this documentation for the purchaser's own internal business purposes. Purchaser shall not remove or alter any proprietary notices, including copyright notices, contained in this documentation and shall ensure that all notices appear on any reproductions of the documentation.

Should future revisions of this manual be published, you can acquire printed versions by contacting your Datalogic representative. Electronic versions may either be downloadable from the Datalogic website (www.datalogic.com) or provided on appropriate media. If you visit our website and would like to make comments or suggestions about this or other Datalogic publications, please let us know via the "Contact Datalogic" page.

Disclaimer

Datalogic has taken reasonable measures to provide information in this manual that is complete and accurate, however, Datalogic reserves the right to change any specification at any time without prior notice.

Datalogic and the Datalogic logo are registered trademarks of Datalogic S.p.A. in many countries, including the U.S. and the E.U. Heron is a trademark of Datalogic S.p.A. and/or its affiliates, registered in the U.S. All other brand and product names may be trademarks of their respective owners.

Patents

See www.patents.datalogic.com for patent list.

See the Regulatory Addendum included with your product for additional regulatory, safety and legal information.



Table of contents

END USER SOFTWARE LICENSE AGREEMENT	iii
Software Product Policy	vi
Using the Heron™ Series Readers	1
Setting Up the Reader	2
Connecting to the Host Interface	2
Disconnecting the Cable	2
Stand Installation	3
Insertion Into Stand	4
Adjusting the Stand Position	5
To adjust the stand:	5
Selecting the Interface Type	6
USB Interface	6
RS-232 Interface.....	7
Keyboard Wedge Interface	8
Audio Jingle	9
Audio Volume.....	9
Keyboard Nationality	10
Country Mode	10
Programming	14
Resetting Product Defaults	14
RGB LED Settings	15
Technical Features	18
LED and Beeper Indications	19
Troubleshooting	20
Datalogic Limited Factory Warranty	21
Ergonomic Recommendations	23
Support Through the Website	23
Cleaning	24
Stand Dimensions	25

DATALOGIC IP TECH S.R.L.

END USER SOFTWARE LICENSE AGREEMENT (EULA) FOR THE HERON™ HD3130

Notice to End User: There are two types of software covered by this END USER LICENSE AGREEMENT ("EULA"): (1) The Datalogic Product you have acquired contains embedded software ("Embedded Software") which is integral to the Product's operation; and (2) Optional Application Software provided to you on an optional basis ("Application Software"). Embedded Software and Application Software are collectively referred to as "Software" and are subject to the terms and conditions contained in this EULA. Software is provided only for use with, and for authorized end users of, the Datalogic Heron™ HD3130 ("Product").

This EULA (End User Software License Agreement) ("EULA" or "Agreement") is a legally binding agreement governing the licensing of the Software and Documentation by Datalogic IP Tech S.r.l. and its subsidiaries and affiliates ("Datalogic") to the entity or person who has purchased or otherwise acquired a Datalogic Product ("End User"). For purposes of this Agreement, any software that is not Embedded Software or Application Software is software associated with a separate end-user license agreement is licensed to you under the terms of that license agreement. Datalogic and End User hereby agree as follows:

1. Definitions

- 1.1 "Affiliate" means a business entity currently existing or later acquired that is controlled by, or is under common control with Datalogic S.p.A.
- 1.2 "Documentation" means materials such as user's guides, program reference guides, quick reference guides, manuals, or similar materials associated with or related to the Datalogic Product, whether in printed, "online", or other form.
- 1.3 "Proprietary Information" means: (a) source code, object code, software, documentation, and any related internal design, system design, data base design, algorithms, technology, technical data or information, implementation techniques, and trade secrets related to the Software, (b) any other trade secrets marked appropriately or identified as proprietary or confidential, and (c) any information that End User, under the circumstances, should recognize as confidential. Proprietary Information does not include any information that the receiving party can establish was (1) in the public domain, (2) already in the receiving party's possession or rightfully known prior to receipt, (3) rightfully learned from a third party not in violation of any other's proprietary rights, or (4) independently developed without access to Proprietary Information.
- 1.4 "Datalogic Product" means the Datalogic Heron™ series scanner product, including all embedded Software in and all Documentation related to such product, which has been purchased or otherwise acquired by End User, whether obtained directly or indirectly from Datalogic.
- 1.5 "Software" means any software or computer programs of Datalogic or its third party licensors in machine readable form which is embedded in the Datalogic Product, whether obtained directly or indirectly from Datalogic, including any replacement, update, upgrade, enhancement or modification.

2. Scope Of License Granted

- 2.1 Datalogic grants to End User a personal, non-exclusive, non-transferable, perpetual license to use the Software, solely on the Datalogic Product in which it is embedded ("designated Datalogic Product"), in machine-readable form only, solely for End User's internal business purposes. This Agreement does not convey ownership of the Software to End User. Title to the Software shall be and remain with Datalogic or the third party from whom Datalogic has obtained a licensed right. As used in this Agreement, the term "purchase" or its equivalents when applied to the Software shall mean "acquire under license." End User is not entitled to receipt or use of the source code to any Software.
- 2.2 End User shall not copy, modify, decompile, disassemble, reverse engineer, or otherwise reproduce or remanufacture the Software, whether modified or unmodified, nor sell, assign, sublicense, distribute, lend, rent, give, or otherwise transfer the Software to any other person or organization, for purposes other than as expressly provided in this Agreement, without Datalogic's prior written consent.

3. Transfers, Support

- 3.1 Any copying, installing, reproduction, remanufacture, reverse engineering, electronic transfer, or other use of the Software on other than the designated Datalogic Product will be a material breach of this Agreement. However, Datalogic may elect not to terminate this Agreement or the granted licenses, but instead may elect to notify End User that End User is deemed to have ordered and accepted a license for each breaching use. End User shall pay Datalogic the applicable list price for such licenses as of

the date of such breach.

- 3.2 End User shall not sell, assign, sublicense, distribute, lend, rent, give, or otherwise transfer the Datalogic Product to any third party unless such third party agrees with Datalogic in writing to be bound by the terms and conditions of this Agreement. Any such transfer of the Datalogic Product absent such agreement shall be null and void.
- 3.3 End User may obtain support for Software from Datalogic at Datalogic's standard support fees and under Datalogic's standard support terms and conditions in effect at the time the support is requested.

4. Intellectual Property

End User acknowledges that the Software comprises valuable trade secrets of Datalogic or Datalogic's third party licensors and that the Software is protected by United States copyright law and trade secret law, and by all applicable international intellectual property laws and treaty provisions. The license set forth in this Agreement does not transfer to End User any ownership of Datalogic's or its third party licensors' copyrights, patents, trademarks, service marks, trade secrets, or other intellectual property rights and End User shall have no right to commence any legal actions to obtain such rights. End User shall not remove, modify, or take any other action that would obscure any copyright, trademark, patent marking, or other intellectual property notices contained in or on the Datalogic Product.

5. Proprietary Information

- 5.1 End User acknowledges that Proprietary Information is the confidential, proprietary, and trade secret property of Datalogic and Datalogic's third party licensors and End User acquires no right or interest in any Proprietary Information.
- 5.2 End User shall not disclose, provide, or otherwise make available the Proprietary Information of Datalogic or its third party licensors to any person other than End User's authorized employees or agents who are under confidentiality agreement, and End User shall not use the Proprietary Information other than in conjunction with use of the Datalogic Product exclusively for End User's internal business purposes. End User shall take steps to protect the Proprietary Information no less securely than if it were End User's own intellectual property.
- 5.3 The provisions of this Proprietary Information Section shall survive and continue for five (5) years after the termination of this Agreement.

6. Limited Warranty

- 6.1 Datalogic warrants that, under normal use and operation, the Datalogic Product will conform substantially to the applicable Documentation for the period specified in the Documentation. During this period, for all reproducible non-conformities for which Datalogic has been given written notice, Datalogic will use commercially reasonable efforts to remedy nonconformities verified by Datalogic. End User agrees to supply Datalogic with all reasonably requested information and assistance necessary to help Datalogic in remedying such nonconformities. For all defects reported to Datalogic within the warranty period, Datalogic's liability is limited to providing End User with one copy of corrections or responding to End User's problem reports according to Datalogic's standard assistance practices. Datalogic does not warrant that the product will meet End User's requirements or that use of the product will be uninterrupted or error free, or that Datalogic's remedial efforts will correct any nonconformance. This limited warranty does not cover any product that have been subjected to damage or abuse, whether intentionally, accidentally, or by neglect, or to unauthorized repair or unauthorized installation, and shall be void if End User modifies the product, uses the product in any manner other than as established in the Documentation, or if End User breaches any of the provisions of this Agreement.
- 6.2 EXCEPT AS PROVIDED IN THIS AGREEMENT, THE DATALOGIC PRODUCT IS PROVIDED "AS IS" AND DATALOGIC MAKES NO WARRANTIES OF ANY KIND, EXPRESS OR IMPLIED, WRITTEN OR ORAL, WITH RESPECT TO THE PRODUCT, AND SPECIFICALLY DISCLAIMS THE IMPLIED WARRANTIES OF MERCHANTABILITY AND FITNESS FOR A PARTICULAR PURPOSE.

7. Infringement

To the maximum extent permitted by law, End User agrees to defend, indemnify and hold harmless Datalogic, its affiliates and their respective directors, officers, employees and agents from and against any and all claims, actions, suits or proceedings, as well as any and all losses, liabilities, damages, costs and expenses (including reasonable attorney's fees) arising out of or accruing from (a) the End User's use of Software, (b) any application the End User develops on the Software that infringes any Intellectual Property Rights of any person or defames any person or violates their rights of publicity or privacy, and (c) any non-compliance by the End User of this Agreement.

8. Limitation Of Liability

DATALOGIC SHALL NOT BE LIABLE FOR ANY CLAIMS AGAINST END USER BY ANY OTHER PARTY. IN NO EVENT SHALL DATALOGIC'S LIABILITY FOR DAMAGES, IF ANY, WHETHER BASED UPON CONTRACT, TORT (INCLUDING NEGLIGENCE), PRODUCT LIABILITY, STRICT LIABILITY, WARRANTY, OR ANY OTHER BASIS, EXCEED THE PRICE OR FEE PAID BY END USER FOR THE DATA- LOGIC PRODUCT. UNDER NO CIRCUMSTANCES SHALL DATALOGIC BE LIABLE TO END USER OR ANY THIRD PARTY FOR LOST PROFITS, LOST DATA, INTERRUPTION OF BUSINESS OR SERVICE, OR FOR ANY OTHER SPECIAL, CONSEQUENTIAL, CONTINGENT, INDIRECT, INCIDENTAL, PUNITIVE, EXEMPLARY, OR OTHER SIMILAR DAMAGES, EVEN IF DATA- LOGIC HAS BEEN ADVISED OF THE POSSIBILITY OF SUCH DAMAGES.

9. Government Restricted Rights; International Use

- 9.1 Use, duplication, or disclosure of the Software by the U.S. Government is subject to the restrictions for computer software developed at private expense as set forth in the U.S. Federal Acquisition Regulations at FAR 52.227-14(g), or 52.227-19 or in the Rights in Technical Data and Computer Software clause at DFARS 252.227-7013(c)(1)(ii), whichever is applicable.
- 9.2 If End User is using the Datalogic Product outside of the United States, End User must comply with the applicable local laws of the country in which the Datalogic Product is used, with U.S. export control laws, and with the English language version of this Agreement. The provisions of the "United Nations Convention on International Sale of Goods" shall not apply to this Agreement.

10. Termination

- 10.1 Either party may terminate this Agreement or any license granted under this Agreement at any time upon written notice if the other party breaches any provision of this Agreement.
- 10.2 Upon termination of this Agreement, End User immediately shall cease using any non-embedded software and shall return to Datalogic or destroy all non-embedded software covered by this Agreement, and shall furnish Datalogic with a certificate of compliance with this provision signed by an officer or authorized representative of End User. For embedded software, End User agrees to sign a waiver prepared by Datalogic concerning further use of the embedded Software. End User's resumed or continued use of the embedded Software after termination shall constitute End User's agreement to be bound by the terms and conditions of this Agreement for such use.

11. General Provisions

- 11.1 Entire Agreement; Amendment. This document contains the entire agreement between the parties relating to the licensing of the Software and supersedes all prior or contemporaneous agreements, written or oral, between the parties concerning the licensing of the Software. This Agreement may not be changed, amended, or modified except by written document signed by Datalogic.
- 11.2 Notice. All notices required or authorized under this Agreement shall be given in writing, and shall be effective when received, with evidence of receipt. Notices to Datalogic shall be sent to the attention of Datalogic IP Tech S.r.l., Legal & IP Department, Via San Vitalino 13, 40012 Calderara di Reno (Bologna), Italy or such other address as may be specified by Datalogic in writing.
- 11.3 Waiver. A party's failure to enforce any of the terms and conditions of this Agreement shall not prevent the party's later enforcement of such terms and conditions.
- 11.4 Governing Law; Venue: Both parties agree to the application of the laws of the country in which End User obtained the license to govern, interpret, and enforce all of End User's and Datalogic's respective rights, duties, and obligations arising from, or relating in any manner to, the subject matter of this Agreement, without regard to conflict of law principles. The United Nations Convention on Contracts for the International Sale of Goods does not apply.

All rights, duties, and obligations are subject to the courts of the country in which End User obtained the license. For licenses granted by Licensee who operates in the countries specified below, the following terms applies.

For Americas.

This Agreement is governed by the laws of the State of Oregon. This Agreement and the rights of the parties hereunder shall be governed by and construed in accordance with the laws of the State of Oregon U.S.A, without regard to the rules governing conflicts of law. The state or federal courts of the State of Oregon located in either Multnomah or Lane counties shall have exclusive jurisdiction over all matters regarding this Agreement, except that Datalogic shall have the right, at its absolute discretion, to initiate proceedings in the courts of any other state, country, or territory in which End User resides, or in which any of End User's assets are located. In the

event an action is brought to enforce the terms and conditions of this Agreement, the prevailing party shall be entitled to reasonable attorneys' fees, both at trial and on appeal.

For Europe, Middle East and Africa

This Agreement is governed by the laws of Italy. This Agreement and the rights of the parties hereunder shall be governed by and construed in accordance with the laws of Italy, without regard to the rules governing conflicts of law. Italian Court of Bologna shall have exclusive jurisdiction over all matters regarding this Agreement, except that Datalogic shall have the right, at its absolute discretion, to initiate proceedings in the courts of any other state, country, or territory in which End User resides, or in which any of End User's assets are located. In the event an action is brought to enforce the terms and conditions of this Agreement, the prevailing party shall be entitled to reasonable attorneys' fees, both at trial and on appeal.

For Asia- Pacific Countries

This Agreement is governed by the laws of the State of Hong Kong. This Agreement and the rights of the parties hereunder shall be governed by and construed in accordance with the laws of the State of Hong Kong without regard to the rules governing conflicts of law. The Court of Hong Kong shall have exclusive jurisdiction over all matters regarding this Agreement, except that Datalogic shall have the right, at its absolute discretion, to initiate proceedings in the courts of any other state, country, or territory in which End User resides, or in which any of End User's assets are located. In the event an action is brought to enforce the terms and conditions of this Agreement, the prevailing party shall be entitled to reasonable attorneys' fees, both at trial and on appeal.

11.5 Attorneys' Fees. In the event an action is brought to enforce the terms and conditions of this Agreement, the prevailing party shall be entitled to reasonable attorneys' fees, both at trial and on appeal.

- END -

Software Product Policy

Datalogic reserves the right to ship its products with the latest version of software/firmware available. This provides our customers with the very latest in Datalogic software technology.

The only exception to this policy is when the buyer has a signed contract with Datalogic that clearly defines the terms and conditions for making software/firmware changes in products shipped to the buyer.

To arrange for a Software Maintenance and Support Agreement please contact your Datalogic sales person.



Heron™ HD3130

Using the Heron™ Series Readers

The Heron™ HD3130 Linear Imager has several new features:

- the reader's attractive illumination (top and sides) selectively changes color to indicate its status.
- the option to use personal jingles (a short user-defined tune uploaded via Datalogic Aladdin™ configuration software) instead of the normal beep tone.

Heron™ readers automatically scan barcodes **at a distance**. Simply aim and pull the trigger. Code scanning is performed along the center of the light bar emitted from the reading window. This bar must cover the entire code.

Effective scanning is obtained by tilting the scanner with respect to the barcode to avoid direct reflections, which impair the reading performance (see Figure 1A below). A successful read is signaled by an audible tone or a jingle (previously uploaded), plus a good-read green spot. The side and upper illuminators become green (unless another color has been configured with Aladdin configurator).

Once the reader is correctly inserted into the stand, it is immediately ready to automatically read any code present in its reading area without pressing the trigger. Furthermore, a green aiming light is continuously emitted to facilitate the positioning of the bar code to be read (shown in Figure 1B).

To guarantee single code reading, consecutive reading of the same code requires the code to be removed from the reading area (no decoding) before the reader will accept the same code again.

Figure 1. Correct positioning of scanner

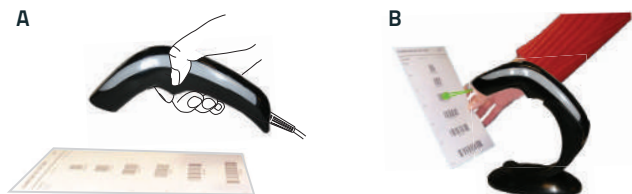

Setting Up the Reader

Follow the steps below to connect and get your reader up and communicating with its host.

1. Connect the Cable to the reader and the Host as shown below.
2. Configure the Interface (see page 6).
3. Program the Reader starting on page 14 (optional, as needed).

Connecting to the Host Interface



Disconnecting the Cable

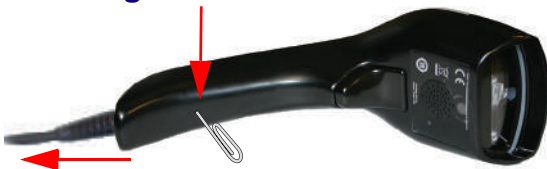

Stand Installation

The stand can be affixed to a flat surface such as a desk or countertop. If needed, it can also be easily removed.

To install the stand:

1. Remove the protective film from the rubber feet and adhere them to the corresponding recessed areas on the bottom surface of the stand.
2. Use the template mask at the back of this manual to locate the desired position of the stand base on the desk.
3. Use a pen to mark the location of the small holes (shown in red) on the desk surface. Remove the mask before installing the screws.



4. Screw the 2 wood screws into the desk, centering in the marked holes. Leave about 4-5 mm of the screw protruding from the upper surface of the desk.



NOTE

On hard surfaces, an electric screwdriver can be used for easier installation of the screws.

5. Set the stand in place on the screws by aligning the large holes (circled in blue) with the screw heads.



6. Rotate the stand counterclockwise until you feel it lock into place.

7. If the rotation is obstructed, or if the stand does not lock into place, remove the stand and adjust the height of the screws. Retry.
8. To remove the stand, rotate clockwise and lift to detach.

Insertion Into Stand

Place the reader into the stand, taking care to insert the handle into the stand clip as shown.



Correct insertion will be signaled by a beep; then, the reader will be ready to read bar codes.

Adjusting the Stand Position

The stand can easily be adjusted to change the inclination of the reader while in the stand.

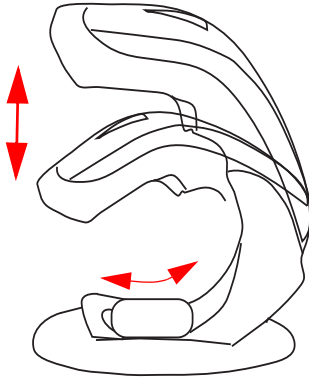

To adjust the stand:

1. With fingers, loosen the screw on the bottom of the stand by turning it counterclockwise.



2. Set the stand upright and slide to adjust to the desired position.



3. Re-tighten the screw to secure the stand.

Selecting the Interface Type

Upon completing the physical connection between the reader and its host, proceed directly to Interface Selection below for information and programming for the interface type the reader is connected to (RS-232, Keyboard Wedge, USB) and scan the appropriate bar code to select your system's correct interface type, according to your application.

For interfaces other than those listed in this manual, see the Heron™ HD3130 Product Reference Guide (PRG), available online at www.datalogic.com.

USB Interface

The reader attaches directly to a USB host, or a powered USB hub, and is powered by it. No additional power supply is required. When using a USB interface, the reader auto-detects the USB connection and defaults to the USB Keyboard interface.

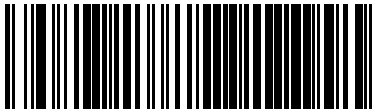

Select USB-COM-STD¹ (simulates RS-232 standard interface)



Select USB Keyboard (with standard key encoding)



Select USB Alternate Keyboard (with alternate key encoding)



Select USB OEM

1. Download the correct USB Com driver from www.datalogic.com.

RS-232 Interface

To use an RS-232 interface, scan the bar code for the desired RS-232 host type.



Select RS-232 Standard

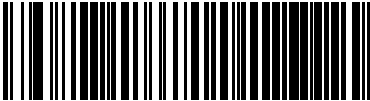

Select RS-232 Wincor Nixdorf

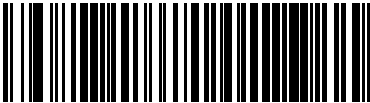

Select RS-232 OPOS (for use with OPOS/UPOS/JavaPOS)

Keyboard Wedge Interface

To use a Keyboard Wedge interface, scan the bar code for the desired keyboard type.

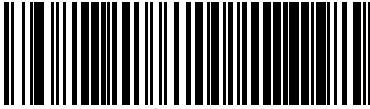

Select KBD-AT
(AT, PS/2 25-286, 30-286, 50, 50Z, 60, 70, 80, 90 & 95
w/Standard Key Encoding)

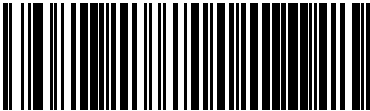

Select KBD-AT-NK
(IBM AT PS2 with standard key encoding
but without external keyboard)

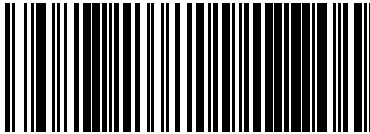

Select KBD-AT-ALT
(AT, PS/2 25-286, 30-286, 50, 50Z, 60, 70, 80, 90 & 95
w/Alternate Key)

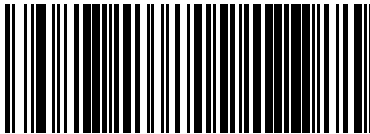

Select KBD-AT-ALT-NK (for IBM AT PS2 with alternate key
encoding but without external keyboard)

Audio Jingle

Instead of the normal beep, a jingle previously uploaded can be selected as the good read audio indication.



Disable Jingle



Enable Jingle

Audio Volume



Volume off



Low Volume



Medium Volume



High Volume

Keyboard Nationality

Country Mode

This feature specifies the country/language supported by the keyboard. .

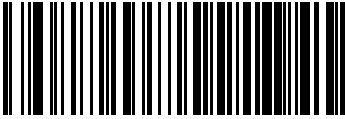
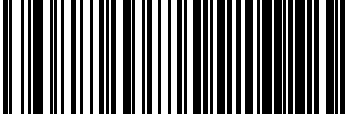
COUNTRY MODE
 ENTER/EXIT PROGRAMMING MODE
 Country Mode = U.S.
 Country Mode = Belgium
 Country Mode = Britain
 Country Mode = Croatia
 Country Mode = Czech Republic

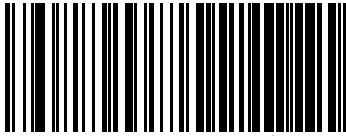
COUNTRY MODE (continued)

Country Mode = Denmark

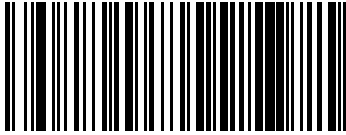

Country Mode = France

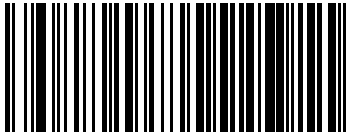

Country Mode = Germany

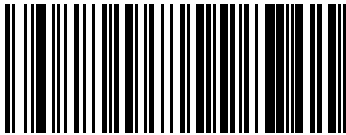

Country Mode = Hungary

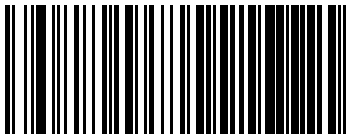

Country Mode = Italy

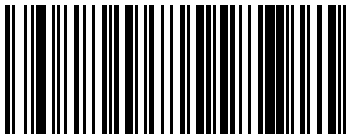

Country Mode = Japanese 106-key

COUNTRY MODE (continued)

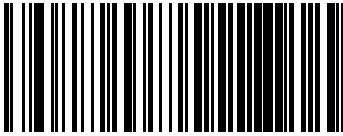

Country Mode = Norway

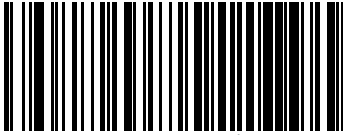

Country Mode = Poland

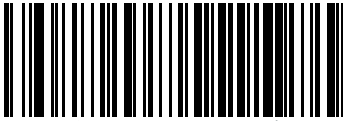

Country Mode = Portugal

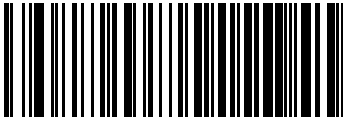

Country Mode = Romania

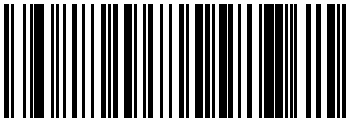

Country Mode = Slovakia

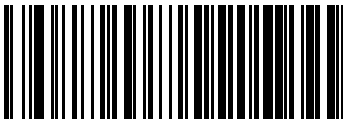

Country Mode = Spain

COUNTRY MODE (continued)

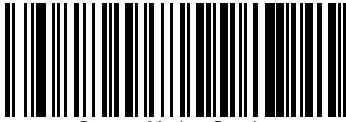

Country Mode = Sweden

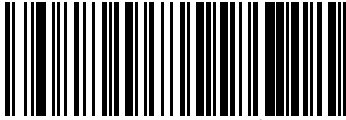

Country Mode = Switzerland

Programming

The reader is factory-configured with a set of standard default features. After scanning the interface barcode from the Interfaces section, select other options and customize your reader through use of the programming bar codes available in the Heron™ HD3130 Product Reference Guide (PRG). Check the corresponding features section for your interface, and also the Data Editing and Symbologies chapters of the PRG.

Resetting Product Defaults

If you aren't sure what programming options are in your reader, or you've changed some options and want the factory settings restored, scan the Factory Default Settings bar code below. This will copy the factory configuration for the currently active interface to the current configuration. To change the settings refer to the Heron™ HD3130 PRG.

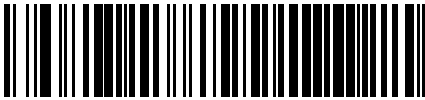

Factory Default Settings

RGB LED Settings

The following configuration items specify settings for the RGB (Red Green Blue) LEDs, which are used to indicate Good Read and Body Illumination when Scanner is in Idle mode. (Only for version 610023419 and later).

GOOD READ LED COLOR	
	ENTER/EXIT PROGRAMMING MODE
	GOOD READ INDICATOR = DISABLE
	◆ GOOD READ INDICATOR = ENABLE
	GOOD READ LED COLOR = RED
	◆ GOOD READ LED COLOR = GREEN
	GOOD READ LED COLOR = BLUE

Scanner Idle LED Color (Only for SW version 610023419 and later)



ENTER/EXIT PROGRAMMING MODE



BODY ILLUMINATION = DISABLE



◆ BODY ILLUMINATION = ENABLE



◆ COLOR = SOLID BLUE



COLOR = SOLID YELLOW



COLOR = SOLID RED



COLOR = SOLID PURPLE



COLOR = SOLID GREEN*



COLOR = RANDOM COLORS



COLOR = TURQUOISE



COLOR = ORANGE



COLOR = FUCHSIA



COLOR = CYAN

* In this case a different Color should be chosen for the Good Read LED.

Technical Features

Heron™ HD3130

Item	Description
Electrical Features	
Power Supply RS-232 interface	5 Vdc ± 5%
Consumption:	Max operating current @ 5V: <500 mA Typical operating (changing colors) current @ 5V < 300 mA
Max. Scan Rate	270 scans/sec
Reading Indicators	Side and Top Illumination, Good Read Spot, Beep or Jingle
Optical Features	
Sensor	CCD solid state (2500 pixels)
Illuminator	LED array
Wavelength	617 nm
LED Safety Class	Exempt IEC 62471
DOF Depth of Field (Typical)	5 mils : 5 to 15.0 cm / 2.0 to 6.0 in (CODE 39, PCS 90%) 10 mils: 2 to 35.0 cm / 0,8 to 13.8 in (CODE 39, PCS 90%) 13 mils: 2 to 40.0 cm / 0,8 to 15.7 in (EAN13, PCS 90%) 20 mils: 2 to 60.0 cm / 0,8 to 23.6 in (CODE 39, PCS 90%)
Max. Resolution	0.10 mm (4 mils)
PCS (Datalogic Test Chart)	minimum 15%
Environmental Features	
Working Temperature	0 °C to + 50 °C (+32° to +122 °F)
Storage Temperature	-20 °C to + 70 °C (-4° to +158 °F)
Humidity	90% non condensing
Drop Resistance	IEC 68-2-32 Test ED 1.5 m (5 ft)
ESD Protection	16 KV
Protection Class	IP40

Item	Description
Mechanical Features	
Weight (without cable)	approx. 150 g (5.3 oz)
Cable Length	Refer to www.datalogic.com
Decode Capability	UPC/EAN, P2 /P5 add-ons; ISBN; ISSN; GTIN, add on 2/5; Codabar; ABC Codabar; Interleaved 2/5; Code 93; Code 128; Code 39; Code 32 (Italian Pharmacode); Code 11; Plessey; Industrial 2/5; IATA Industrial 2/5; EAN 128; Code 4; Code 5; China Post (Datalogic 2 of 5); Standard 2 of 5; MSI; Concatenated ISBT 128 STACKED CODES: GS1 DataBar Expanded; GS1 DataBar Limited; GS1 DataBar Omnidirectional

LED and Beeper Indications

The imager's beeper sounds and its illumination flashes or changes color to indicate various functions or errors on the reader. A 'Green Spot' also lights to indicate a good read. The tables below list these indications. Reference the PRG for a more detailed list.

Indication	LED	Beeper
Power-up	Upper LED flashes/blinks on power-up, however, this may be too rapid to view. With a USB interface, the LED blinks until enumeration with the host is completed.	Imager beeps four times at highest frequency and volume upon power-up.
Good Read	Upper green LED comes on for programmed time (default). LED behavior for this indication is configurable using Aladdin utility.	One beep at current frequency, volume, mono/bi-tonal setting upon a successful label scan. It is also possible to upload custom jingles with Aladdin.
ROM Failure	200ms on / 200ms off	Imager sounds one error beep at highest volume for 200 mS.
Limited Scanning Label Read	N/A	Imager 'chirps' six times at the highest frequency and current volume.
Imager Disabled	The LED blinks continuously 100mS on / 900 mS off	N/A

Troubleshooting

Problem	Possible Cause	Possible Solutions
Nothing happens when the scan button is pulled.	No power to the imager.	Check system power. Ensure power supply is connected.
	Interface or power cables are loose.	Ensure all cable connections are secure.
LED comes on, but bar code does not decode.	Imager not programmed for correct bar code type.	Ensure imager is programmed to read the type of bar code scanned. Refer to the PRG for more information.
	Bar code label is unreadable.	Check the label to ensure it is not defaced. Try scanning another bar code type.
	Distance between imager and bar code is incorrect.	Move imager closer to or further from the bar code.
Bar code is decoded but not transmitted to the host.	Imager not programmed for the correct host type.	Scan the appropriate host type barcode. Refer to the PRG for more information.



For detailed troubleshooting, refer to the PRG (Product Reference Guide)

Datalogic Limited Factory Warranty

Warranty Coverage

Datalogic warrants to Customer that Datalogic's products will be free from defects in materials and workmanship for a period of five (5) years from product shipment. Datalogic ("Datalogic") hardware products are warranted against defects in material and workmanship under normal and proper use. The liability of Datalogic under this warranty is limited to furnishing the labor and parts necessary to remedy any defect covered by this warranty and restore the product to its normal operating condition. Repair or replacement of product during the warranty does not extend the original warranty term. Products are sold on the basis of specifications applicable at the time of manufacture and Datalogic has no obligation to modify or update products once sold.

If Datalogic determines that a product has defects in material or workmanship, Datalogic shall, at its sole option repair or replace the product without additional charge for parts and labor, or credit or refund the defective products duly returned to Datalogic. To perform repairs, Datalogic may use new or reconditioned parts, components, subassemblies or products that have been tested as meeting applicable specifications for equivalent new material and products. Customer will allow Datalogic to scrap all parts removed from the repaired product. The warranty period shall extend from the date of shipment from Datalogic for the duration published by Datalogic for the product at the time of purchase (Warranty period). Datalogic warrants repaired hardware devices against defects in workmanship and materials on the repaired assembly for a 90 day period starting from the date of shipment of the repaired product from Datalogic or until the expiration of the original warranty period, whichever is longer. Datalogic does not guarantee, and it is not responsible for, the maintenance of, damage to, or loss of configurations, data, and applications on the repaired units and at its sole discretion can return the units in the "factory default" configuration or with any software or firmware update available at the time of the repair (other than the firmware or software installed during the manufacture of the product). Customer accepts responsibility to maintain a back up copy of its software and data.

Warranty Claims Process

In order to obtain service under the Factory Warranty, Customer must notify Datalogic of the claimed defect before the expiration of the applicable Warranty period and obtain from Datalogic a return authorization number (RMA) for return of the product to a designated Datalogic service center. If Datalogic determines Customer's claim is valid, Datalogic will repair or replace product without additional charge for parts and labor. Customer shall be responsible for packaging and shipping the product to the designated Datalogic service center, with shipping charges prepaid. Datalogic shall pay for the return of the product to Customer if the shipment is to a location within the country in which the Datalogic service center is located. Customer shall be responsible for paying all shipping charges, duties, taxes, and any other charges for products returned to any other locations. Failure to follow the applicable RMA policy, may result in a processing fee. Customer shall be responsible for return shipment expenses for products which Datalogic, at its sole discretion, determines are not defective or eligible for warranty repair.

Warranty Exclusions

The Datalogic Factory Warranty shall not apply to:

- (i) any product which has been damaged, modified, altered, repaired or upgraded by other than Datalogic service personnel or its authorized representatives;

- (ii) any claimed defect, failure or damage which Datalogic determines was caused by faulty operations, improper use, abuse, misuse, wear and tear, negligence, improper storage or use of parts or accessories not approved or supplied by Datalogic;
- (iii) any claimed defect or damage caused by the use of product with any other instrument, equipment or apparatus;
- (iv) any claimed defect or damage caused by the failure to provide proper maintenance, including but not limited to cleaning the upper window in accordance with product manual;
- (v) any defect or damage caused by natural or man-made disaster such as but not limited to fire, water damage, floods, other natural disasters, vandalism or abusive events that would cause internal and external component damage or destruction of the whole unit, consumable items;
- (vi) any damage or malfunctioning caused by non-restoring action as for example firmware or software upgrades, software or hardware reconfigurations etc.;
- (vii) the replacement of upper window/cartridge due to scratching, stains or other degradation and/or
- (viii) any consumable or equivalent (e.g., cables, power supply, batteries, keypads, touch screen, triggers etc.).

No Assignment

Customer may not assign or otherwise transfer its rights or obligations under this warranty except to a purchaser or transferee of product. No attempted assignment or transfer in violation of this provision shall be valid or binding upon Datalogic.

DATALOGIC'S LIMITED WARRANTY IS IN LIEU OF ALL OTHER WARRANTIES, EXPRESS OR IMPLIED, ORAL OR WRITTEN, STATUTORY OR OTHERWISE, INCLUDING, WITHOUT LIMITATION, ANY IMPLIED WARRANTIES OF MERCHANTABILITY, FITNESS FOR A PARTICULAR PURPOSE, OR NONINFRINGEMENT. DATALOGIC SHALL NOT BE LIABLE FOR ANY DAMAGES SUSTAINED BY CUSTOMER ARISING FROM DELAYS IN THE REPLACEMENT OR REPAIR OF PRODUCTS UNDER THE ABOVE. THE REMEDY SET FORTH IN THIS WARRANTY STATEMENT IS THE CUSTOMER'S SOLE AND EXCLUSIVE REMEDY FOR WARRANTY CLAIMS. UNDER NO CIRCUMSTANCES WILL DATALOGIC BE LIABLE TO CUSTOMER OR ANY THIRD PARTY FOR ANY LOST PROFITS, OR ANY INCIDENTAL, CONSEQUENTIAL IN-DIRECT, SPECIAL OR CONTINGENT DAMAGES REGARDLESS OF WHETHER DATALOGIC HAD ADVANCE NOTICE OF THE POSSIBILITY OF SUCH DAMAGES.

Risk of Loss

Customer shall bear risk of loss or damage for product in transit to Datalogic. Datalogic shall assume risk of loss or damage for product in Datalogic's possession. In the absence of specific written instructions for the return of product to Customer, Datalogic will select the carrier, but Datalogic shall not thereby assume any liability in connection with the return shipment.

Ergonomic Recommendations



CAUTION

In order to avoid or minimize the potential risk of ergonomic injury follow the recommendations below. Consult with your local Health & Safety Manager to ensure that you are adhering to your company's safety programs to prevent employee injury.

- Reduce or eliminate repetitive motion
- Maintain a natural position
- Reduce or eliminate excessive force
- Keep objects that are used frequently within easy reach
- Perform tasks at correct heights
- Reduce or eliminate vibration
- Reduce or eliminate direct pressure
- Provide adjustable workstations
- Provide adequate clearance
- Provide a suitable working environment
- Improve work procedures.

Support Through the Website

Datalogic provides several services as well as technical support through its website.

Log on to www.datalogic.com and click on the **SUPPORT > General Duty Handheld Scanners** category link. From this page you can select your product model from the dropdown list which gives you access to:

Downloads including Data Sheets, Manuals, Software & Utilities, and Drawings;

Repair Program for On-Line Return Material Authorizations (RMAs) plus Repair Center contact information;

Service Program containing details about Maintenance Agreements;

Technical Support through email or phone.

Cleaning

Exterior surfaces and scan windows exposed to spills, smudges or debris require periodic cleaning to ensure best performance during scanning.

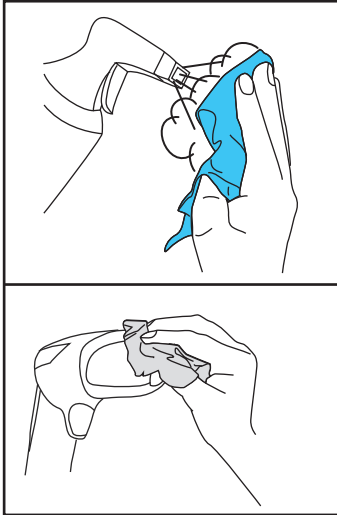

Use a soft, dry cloth to clean the product. If the product is very soiled, clean it with a soft cloth moistened with a diluted non-aggressive cleaning solution or diluted ethyl alcohol.



CAUTION

Do not use abrasive or aggressive cleansing agents or abrasive pads to clean scan windows or plastics.

Do not spray or pour liquids directly onto the unit.

Stand Dimensions

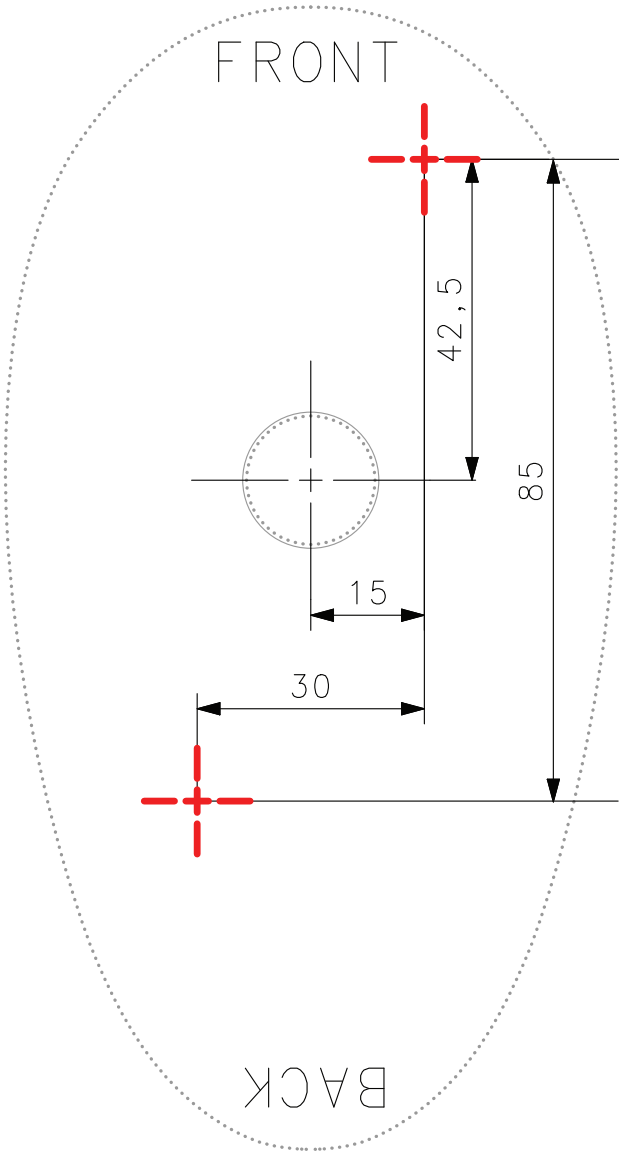

Stand Base Plate Template





www.datalogic.com

©2014-2017 Datalogic S.p.A. and/or its affiliates. All rights reserved. Datalogic and the Datalogic logo are registered trademarks of Datalogic S.p.A. in many countries, including the U.S.A. and the E.U. Heron is a trademark of Datalogic S.p.A. and/or its affiliates, registered in the U.S.

Datalogic USA, Inc.

959 Terry Street | Eugene, OR 97402 | USA
Telephone: (541) 683-5700 | Fax: (541) 345-7140



820095914

(Rev D)

June 2017